

snom 370

VoIP Business Phone



Quick Installation Kurzanleitung

Note to the reader

This is a quick guide to the installation and operation of the snom 370. The full manual will be available on our web page, www.snom.com.

© 2007 snom technology Aktiengesellschaft.

All Rights Reserved. This document is supplied by snom technology AG. No part of this document may be reproduced, republished or retransmitted in any form or by any means whatsoever, whether electronically or mechanically, including, but not limited to, by way of photocopying, recording, information recording or through retrieval systems, without the express written permission of snom technology AG.

snom technology AG reserves the right to revise this document and make changes at any time and without the obligation to notify any person and/or entity of such revisions and/or changes.

Product specifications contained in this document are subject to change without notice.

Table of Contents

Note to the reader	2
Installation	5
Delivery Content	5
Safety Information.....	5
Power supply	5
Setting up the Phone	6
Wall Mounting	6
Cleaning.....	10
Connecting the phone	11
Keypad	13
Index	17

Installation



Delivery Content

Please check whether the delivery contains the following parts:

- The base unit with display and keypad
- The handset
- The handset cable
- The power supply (optional)

Safety Information



Please read the following safety notices before installing or using your snom phone. They are crucial for the safe and reliable operation of the device.

Power supply

You have two options for providing the snom 370 with power:

- An external power supply (5 V)
- Power feeding over the network cable (IEEE 802.3af compatible)

If you want to use an external power supply, use the one that is included in the package. Other power supplies may cause damage to the phone, affect its behavior or induce noise.

Setting up the Phone

Your snom 370 is delivered with the footstand attached to the phone's bottom shell (shaded gray in Fig. 1). Place the snom 370 on an even, horizontal surface that gives the rubber pads a secure grip. Do not place it on carpets or other materials containing fibers that could block the air vents and cause overheating.

After connecting the phone (see chapter *Connecting the Phone*, below), clip the cords into the appropriate slots on the footstand or, in the case of the handset cord, on the bottom shell of the phone (Fig. 2).

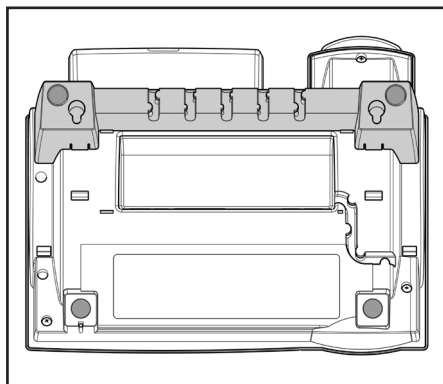

Fig. 1

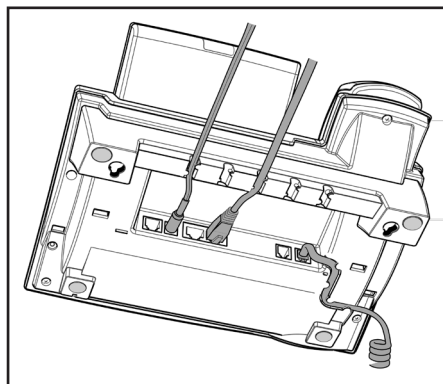

Fig. 2

Wall Mounting

It is also possible to mount the snom 370 on the wall. In order to do this, you detach the footstand from the bottom shell and attach it in the appropriate position for wall mounting, as described in steps 1 through 6, below.

CAUTION: Do not mount the additional keypad available for the snom 370 on the wall. If you wish to use the additional

keypad available for the snom 370, you must place phone and keypad on an even, horizontal surface, as described above.

- 1** Turn the phone upside down (Fig. 3). Please, ensure that you do not damage the display and/or its hinge and that you do not drop the receiver. You may want to hold the phone in your lap or have a second person hold it.

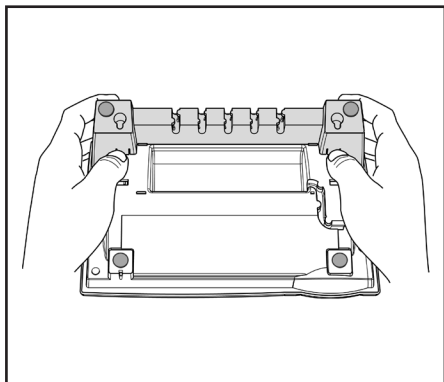

Fig. 3

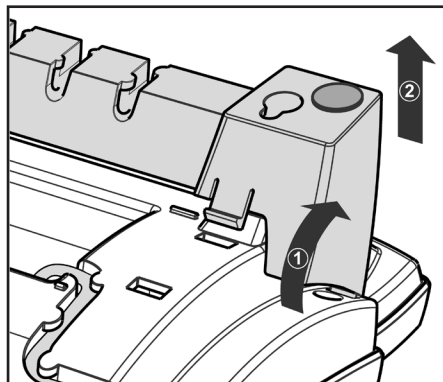

Fig. 4

- 2** Lightly press the snap-fits of the footstand inwards (Fig. 3) and, at the same time, tilt the footstand backwards and lift it from its anchorage in the mounting holes (Fig. 4).
- 3** Rotate the footstand 180° around its vertical axis.
- 4** Make sure that the handset cord has been clipped correctly into the groove on the bottom shell of the phone, as shown in Figs. 4 and 6. Failure to clip the cord into the groove will result in damage to the cord when the footstand is attached in the position for wall mounting.

- 5** Insert the outside, rear snap-fits into the mounting holes on the bottom shell (Fig. 5, arrow no. 1). Tilt the footstand forward and downward until the snap-fits snap into place in the mounting holes. **Please, make sure that the four snap-fits have securely snapped into the holes before mounting the phone on the wall.**

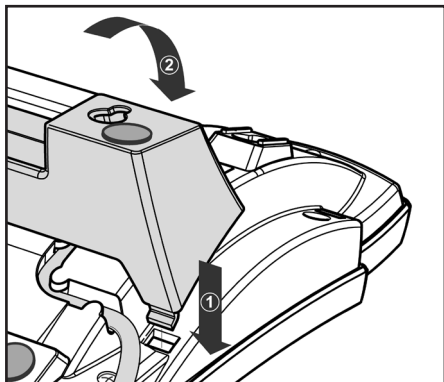

Fig. 5

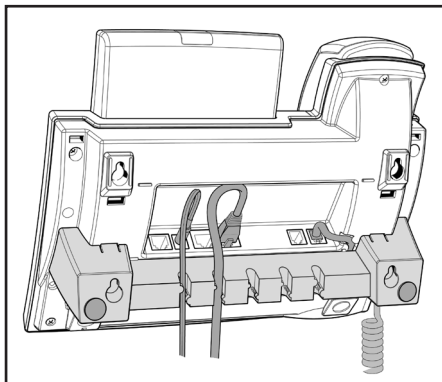

Fig. 6

- 6** The slots on the footstand for the various cords can also be used when the phone is mounted on a wall. After connecting the phone (see chapter *Setting up the Phone*, above), form the cords into loops and gently press the long ends into the slots on the footstand. The loops should not be too big, so that they will not hamper the secure mounting of the phone on the wall, and not too small, so that the cords will not be bent or broken (Fig. 6).

The delivery includes a template to be used for marking the position of the holes to be drilled in the wall.

(Use wall plugs, if necessary, and screws with half-round head profiles (diameters of screws $d_{max} = 4.5 \text{ mm}$ (0.1755"), diameters of heads $d_{max} = 8.5 \text{ mm}$ (0.3315").

The screws must protrude approx. 0.5 cm (0.195") from the wall for easy wall mounting of the phone.

Adjusting the Handset Rest

The speaker of the handset has a small, rectangular indentation that fits over the rounded end of the plastic tab inserted into a slot on the top shell of the phone. When the phone is mounted on the wall, the handset must be placed on this rounded end to ensure that it will not fall off.

Slide the tab out of the slot, as shown in Fig. 7, rotate it 180°, and slide it back into the slot, as shown in Fig. 8.

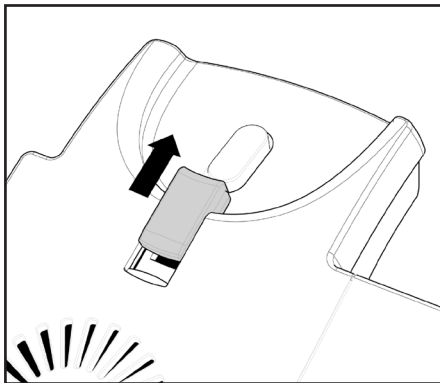

Fig. 7

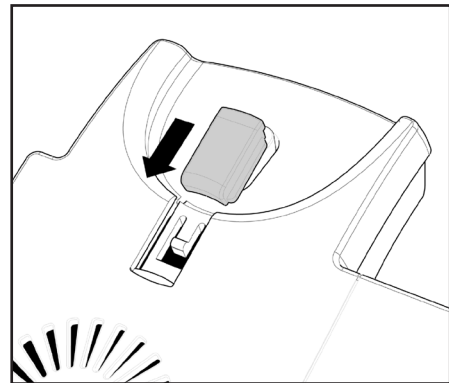

Fig. 8

Adjusting the Position of the Display

The position of the snom 370's display is adjustable up to an angle of 45° (Figs. 9 and 10).

Hold down the phone with one hand and adjust the display with your other hand. Do not use too much force and do not pull, wrench, or twist the display as this might damage or break the hinges.

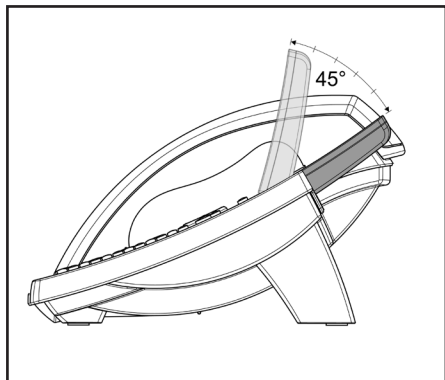

Fig. 9

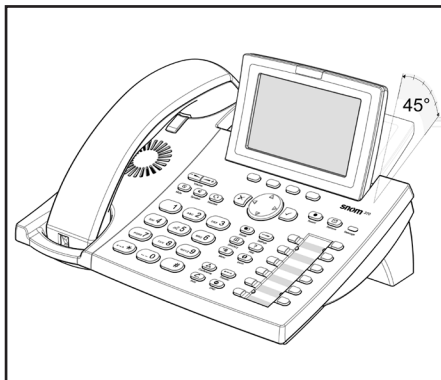

Fig. 10

Cleaning

To clean the snom 370, use an anti-static cloth. Please avoid cleaning liquids as they might damage the surface or internal electronics of the phone.

Connecting the phone



First connect one end of the handset cable to the handset and then to the jack labeled "☎" on the left-hand side of the phone's bottom.

Next plug the Ethernet (network) cable into the RJ45 connector labeled "NET", and plug the other end into the network side to establish a data link. The second RJ45 connector, labeled "PC", is for daisy-chaining further Ethernet devices without the need for a second Ethernet connection line.

If you are using an external power supply, please insert the plug of the power supply into the connector labeled "DC 5V" next to the data line and hook up the casing into the mains.

If you want to use a headset, it can be connected to the audio jack labeled "🎧" on the bottom shell of the snom 370.

Clip the cords into the appropriate slots on the footstand or, in the case of the handset cord, on the bottom shell of the phone (see Fig. 1 in the chapter *Setting up the phone*, above).



Keypad



The numeric keypad with the keys 0 to 9, *, and # is used to enter digits and letters. Depending on the operating mode, different actions can be performed (see the table below):

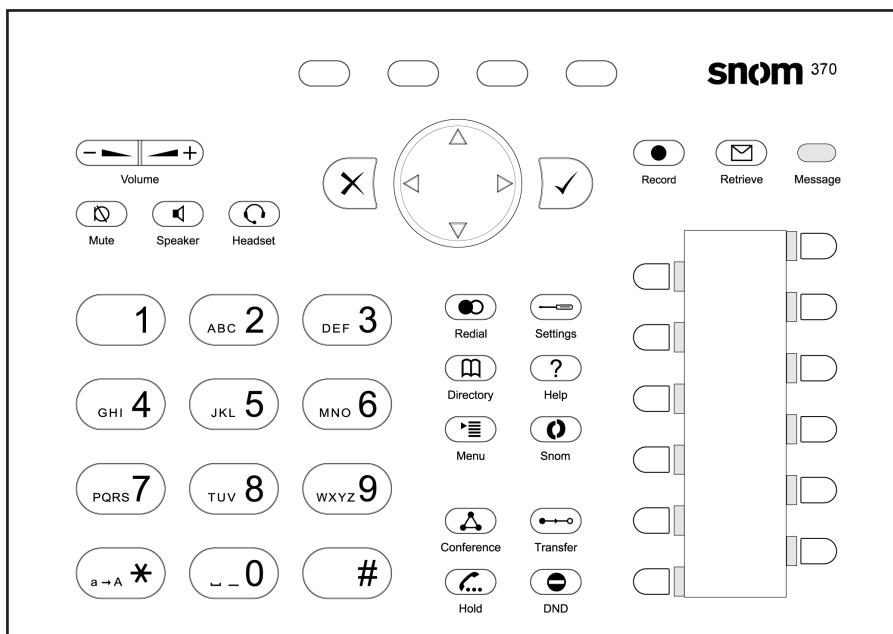

- Entry of digits only (e.g., when dialing a phone number)
- Typing in letters and digits by pressing the keys repeatedly (similar to a cellular phone), etc.



Use the MENU key  to call up the main menu. To cancel actions or input, use the CANCEL key . The ENTER key  confirms actions, selections and inputs. For navigation, use the large round navigation key in the middle.

Depending on the operating mode, the keys can have context-specific meanings which are described in the manual.











The four soft keys located below the display are context-sensitive function keys. Their current mapping is depicted with symbols in the bottom line on the display.



The twelve keys on the right with LEDs  /  next to them are the programmable function keys onto which different functionalities can be mapped.

By default they are mapped to trunk lines. An incoming call is indicated by the fast-blinking LED of the trunk line. To pick it up, press the corresponding key.











To put the call on hold, press the key again. To pick up a call on hold, as indicated by the slow-blinking LED, press the corresponding key.

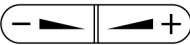





The keys of the numeric block in different operating modes:

Key	Digits	Lower case	Upper case
	0	(SPC)_0	(SPC)_0
	1	.@1,?!-/(:); &%* #+<=>\$[]	.@1,?!-/(:); &%* #+<=>\$[]
	2	abc2	ABC2
	3	def3	DEF3
	4	ghi4	GHI4
	5	jkl5	JKL5
	6	mno6	MNO6
	7	pqrs7\$	PQRS7\$
	8	tuv8	TUV8
	9	wxyz9	WXYZ9

Key	Digits	Lower and upper case
	"#" or "." after timeout	Number guessing
	*	Toggles upper and lower case, when pressed briefly. Locks the keyboard when pressed for a few seconds, as indicated by a small lock symbol on the display; pressing the key again for a few seconds will unlock the keyboard.

Additionally, the following keys are available:

Key	Description
	Mute microphone on/off
	Casing speaker on/off
	Headset on/off
	Adjust volume (lower/higher)
	Opens the phone book. Use the navigation key to scroll within the phone book.
	Shows IP and MAC addresses and firmware version currently installed.
	Menu
	Redial
	Maintenance menu
	Freely programmable key
	Establish 3-party-conference
	Do not disturb mode on/off

Key	Description
	Call hold/unhold
	<p>Call transfer.</p> <p>Announced transfer: Put the call on hold as described above or by pressing  and dial the number it is to be transferred to. When the phone is answered, press the TRANSFER key.</p> <p>Blind transfer: With the caller on the line, press the TRANSFER key, then dial the phone number the call is to be transferred to and press .</p>
	Record a call (with PBX support only)
	Connect to Mailbox (with PBX support only)
	LED for Message Waiting Indication (MWI) – blinking – or indication of missed calls

Index



A

Additional keypad 6
Adjust volume 15

C

Call hold/unhold 14, 16
Call transfer 16
CANCEL key 13
Casing speaker 15
Cleaning 10
Connecting the phone 6, 11
Connect to Mailbox 16

D

Display 9
Do not disturb 15

E

ENTER key 13

H

Handset rest 9

I

Installation 5

K

Keypad 13

L

LEDs 14
LED for MWI 16

M

Maintenance menu 15
Menu 15
 MENU key 13
Mute microphone 15

N

Numeric block 14
Numeric keypad 13

O

Open phone book 15

P

Power supply 5

External power supply 5

Power feeding 5

R

Record a call 16

Redial 15

4

S

Safety information 5

Setting up the phone 6

Soft keys 14

W

Wall mounting 6

Copyright © 2000–2007 snom technology AG. All rights reserved. snom is a registered trademark of snom technology AG and affiliates in Germany, USA and certain other countries and regions. Unless specified otherwise, all trademarks, in particular product names, in this document are legally protected trademarks of snom technology AG. Other trademarks or registered trademarks mentioned in this document are the property of their respective manufacturers or owners. Product specifications contained in this document are subject to change without notice.

